



# Unveiling the Industry's Most Comprehensive Custom ASIC Offering

**Kevin O'Buckley**

General Manager of ASIC Business Unit

July 2020

# Overview

Company founded

**1995**

FY20 revenue

**\$2.7B**

Employees

**5,000+**

Patents worldwide

**10,000+**

Located in **Santa Clara, CA**

R&D centers in **US, Israel, India, Germany, China**



# Marvell's Mission

We develop and deliver semiconductor solutions that move, store, process and secure the world's data faster and more reliably than anyone else.

# Marvell offers the most complete data infrastructure portfolio



## Processors

#1 in baseband and  
data plane processors



## Storage

#1 in HDD and SSD  
controllers, Fibre Channel

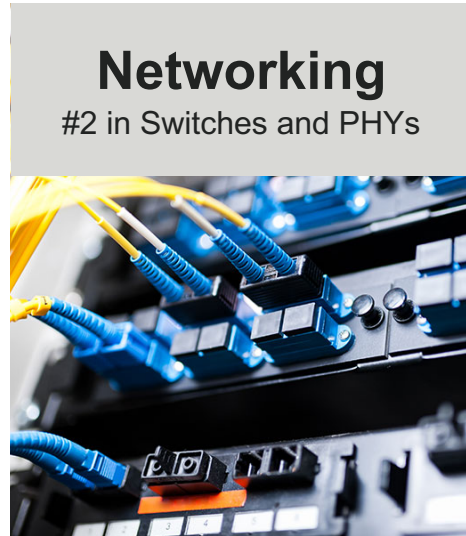

## Networking

#2 in Switches and PHYs

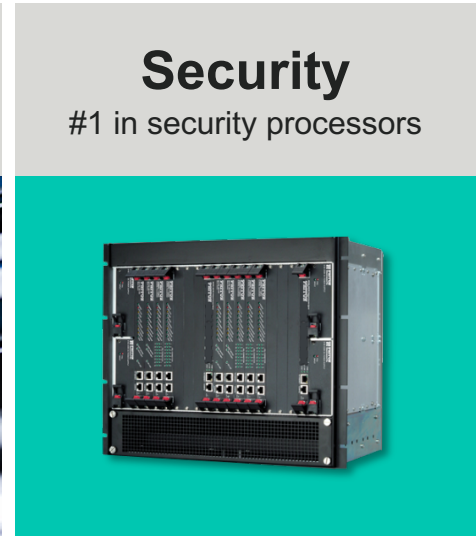

## Security

#1 in security processors

# Industry-leading data infrastructure IP portfolio

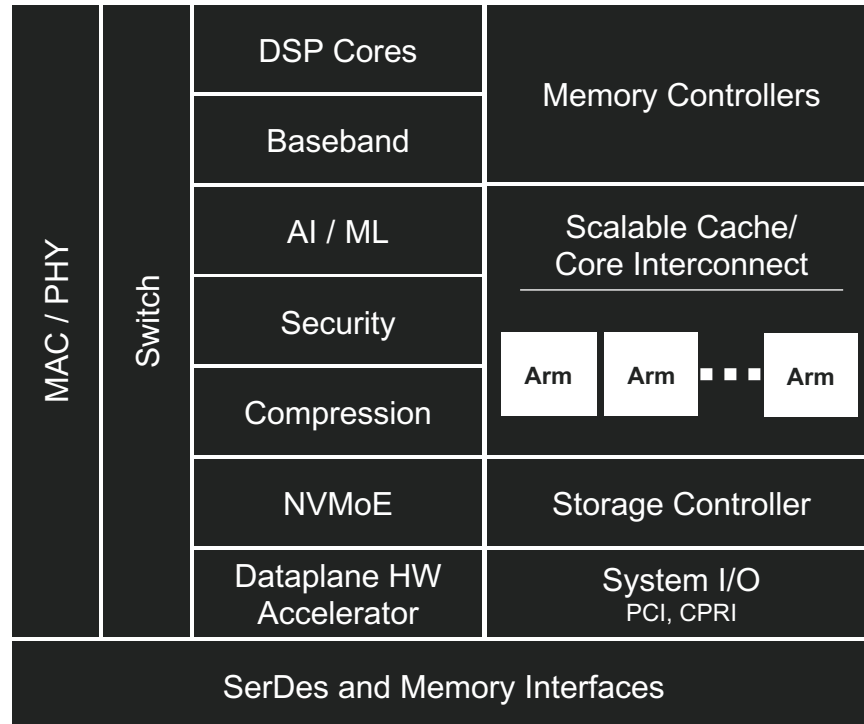

# Acquired custom ASIC leader Avera

Becoming one-stop  
data infrastructure  
semiconductor partner



# Avera brings 25-year custom ASIC track record

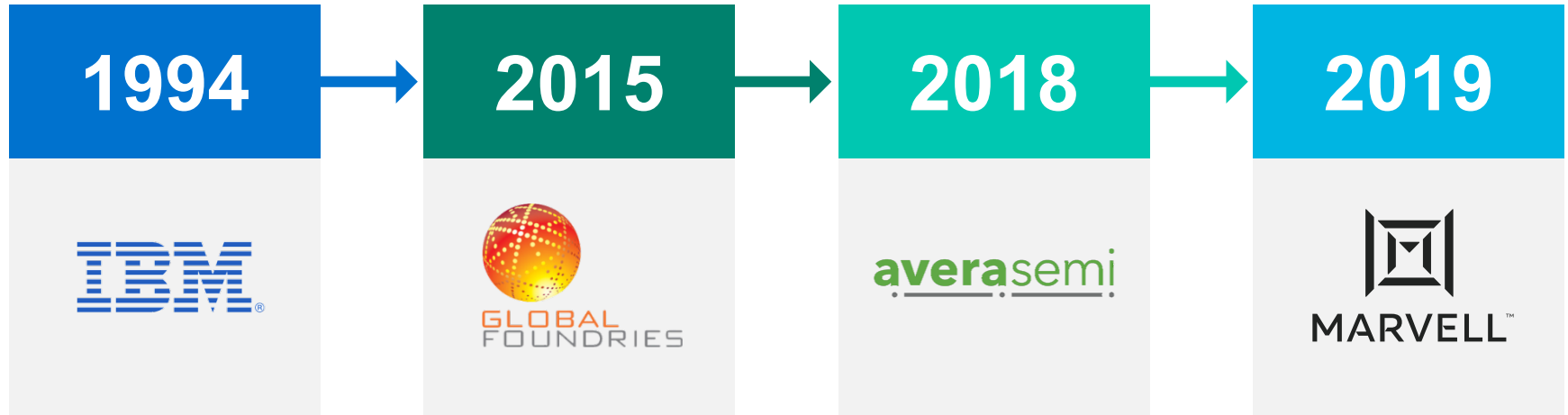

# Combination accelerates innovation and capabilities

**Best-in-class  
standard product IP  
portfolio and scale**

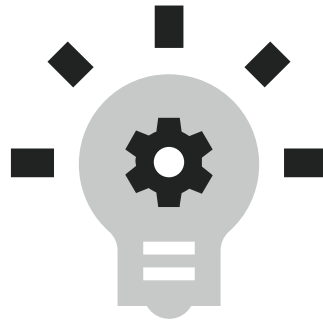

Optimized IPs and  
technologies in  
leading-node geometries

**25 years  
of custom  
ASIC execution**





# Unveiling industry's most comprehensive offering

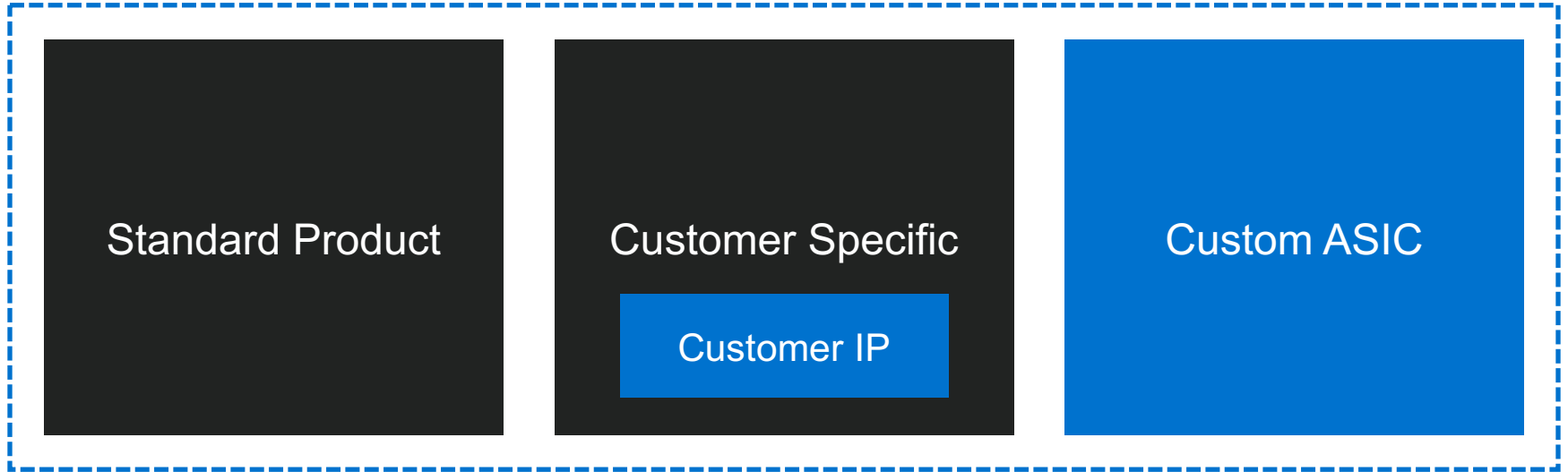

Standard products to custom ASICs with everything in between

# Leveraging best-in-class standard product portfolio

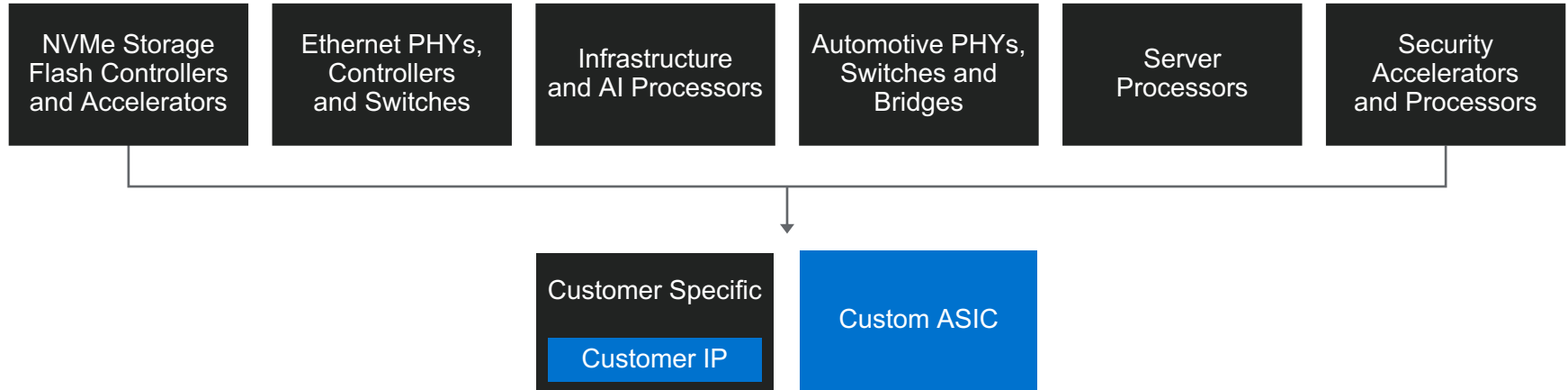

# Marvell Standard Products (ASSP)

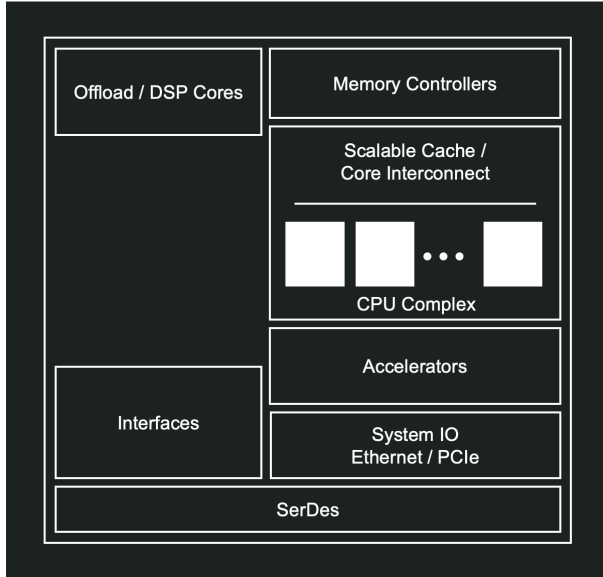

# Marvell Customer Specific Standard Product (CSSP)

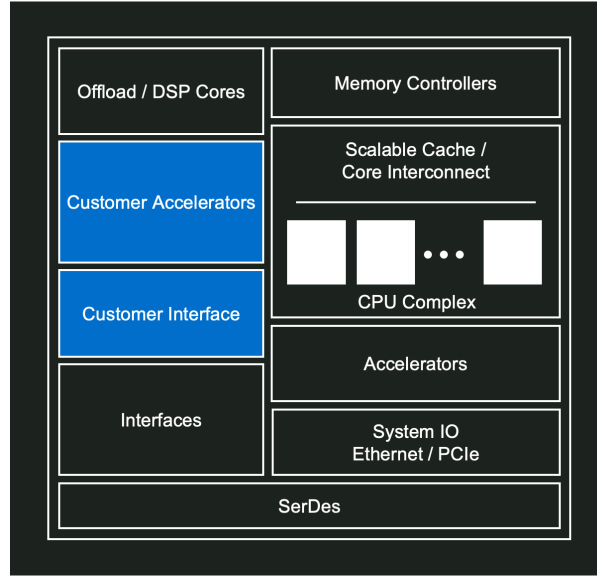

# Custom ASIC solution using optimized Marvell IP

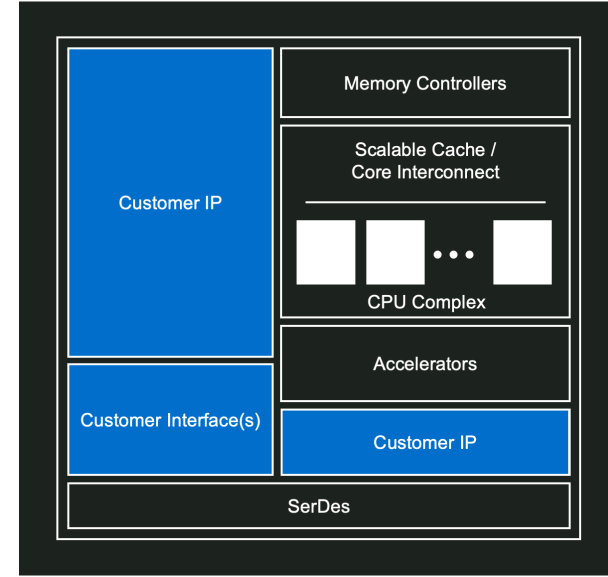

■ Marvell ■ Customer

# Enabling custom silicon across multiple markets

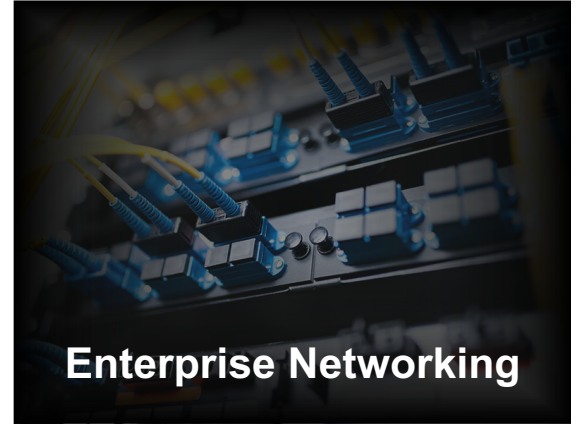
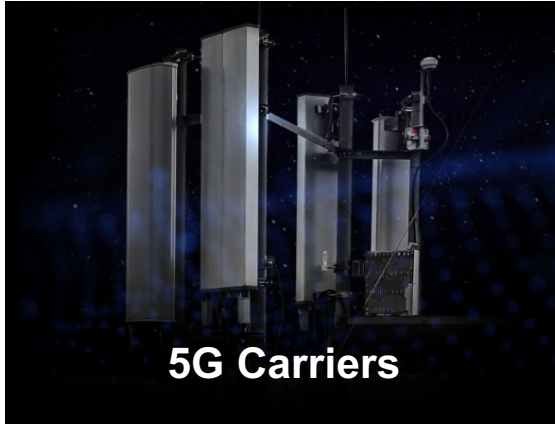

# Marvell Custom ASIC for Wireless Networking

Original  
capability

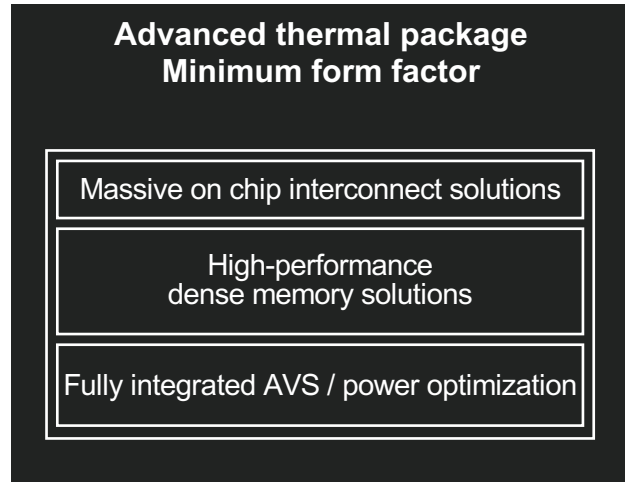

Enhanced  
capability

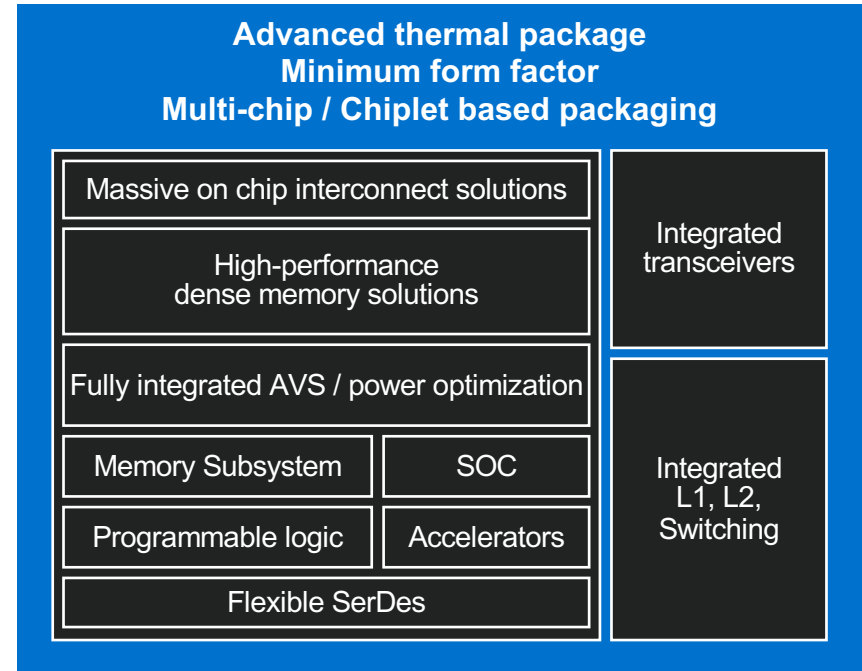

# Marvell Custom ASIC for Wired Networking

Original capability

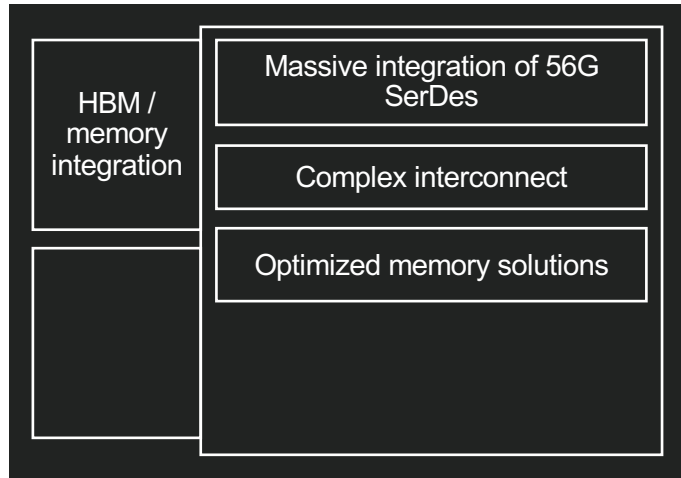
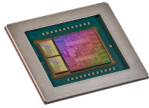

Enhanced capability

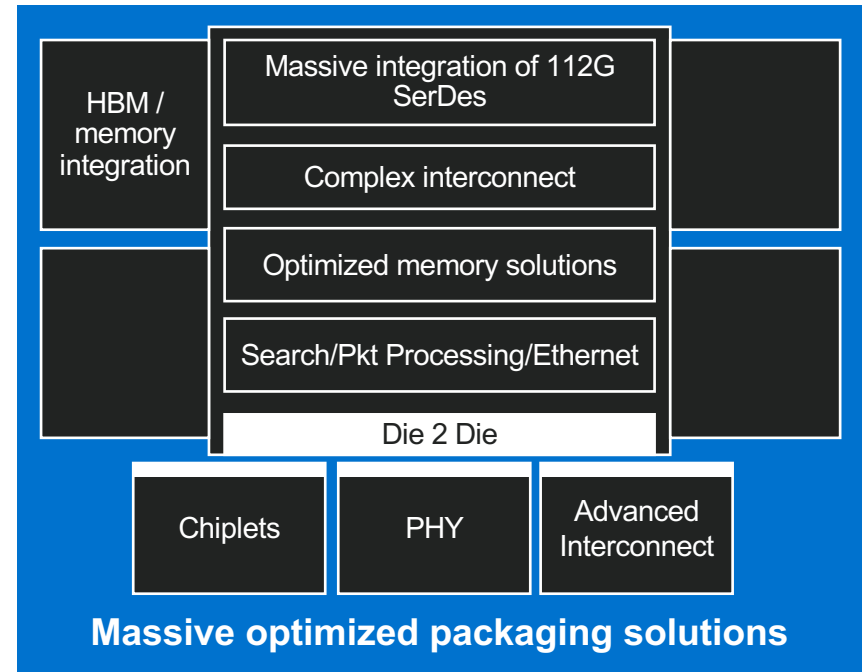
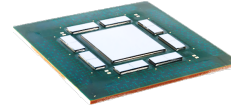

**Massive optimized packaging solutions**

# Marvell Custom ASIC for Cloud Data Centers

Original  
capability

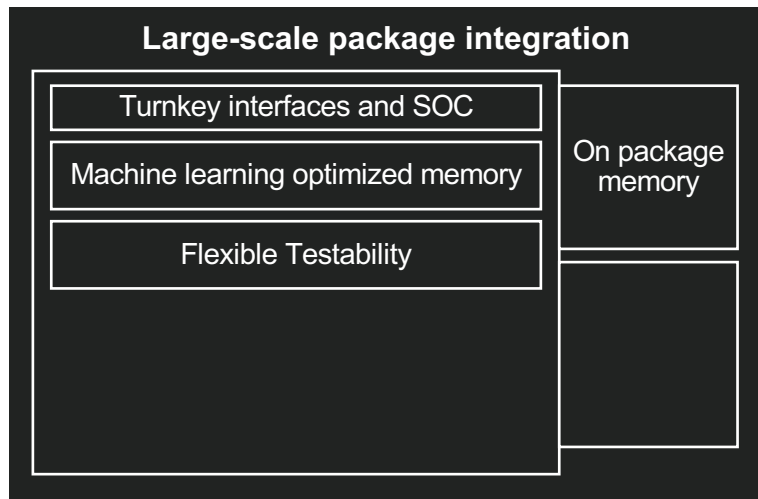

Enhanced  
capability

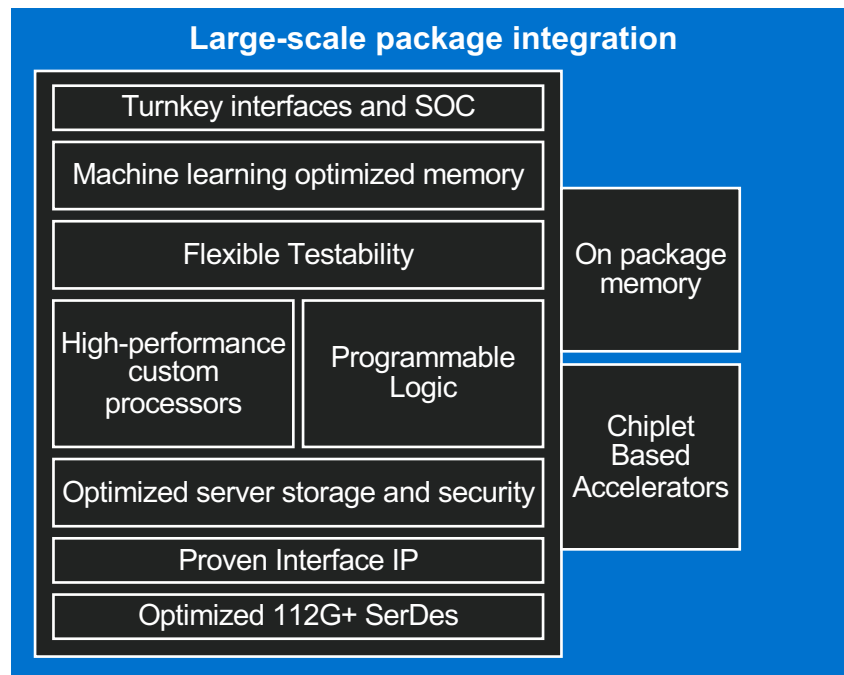

# Critical Custom ASIC Technology Differentiators



Optimized application  
and Arm SoC  
subsystem IPs



First time right  
qualified design flow

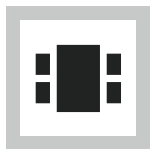

Advanced  
multi-chip packaging



Power optimized  
performance at the  
leading edge



# Flexible custom ASIC engagement business models

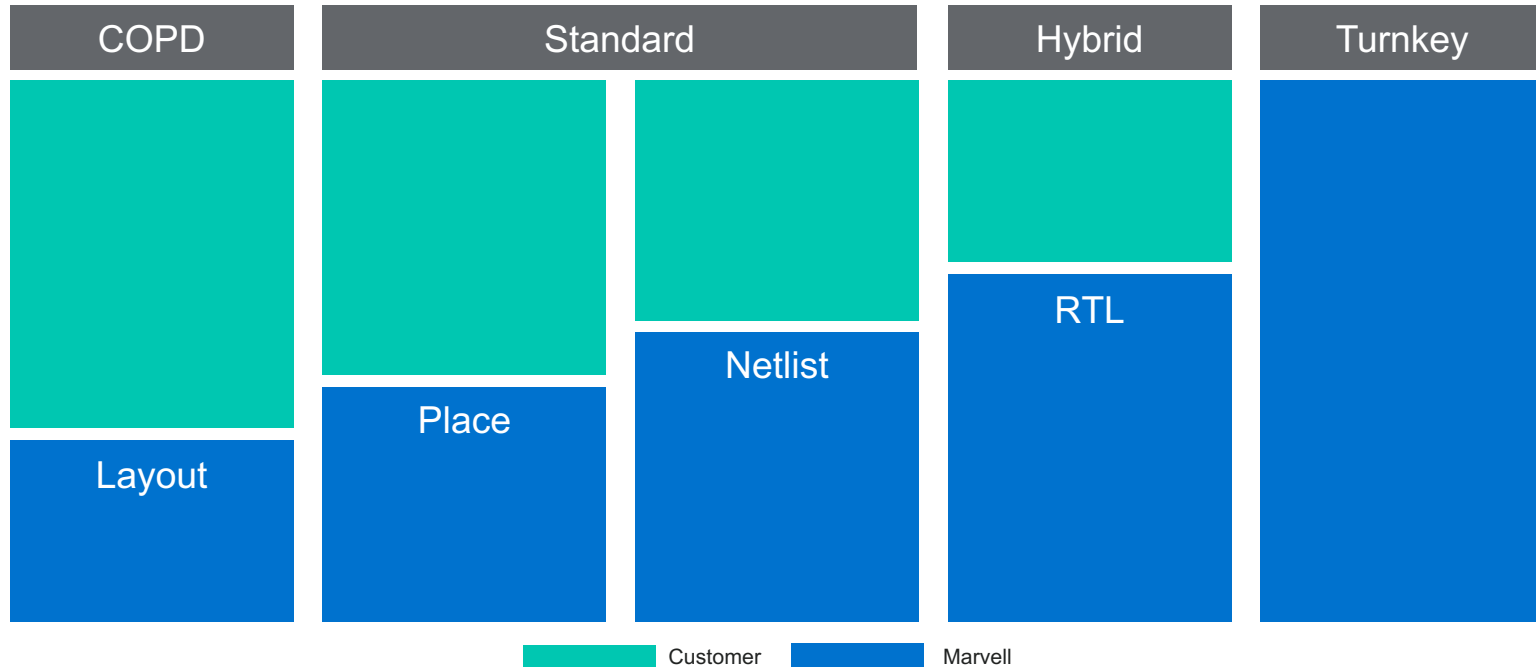

Close collaboration from design architecture start to tapeout release

# Global engineering capability



# Key takeaways

**1** With Avera, Marvell is the only one-stop semiconductor infrastructure provider

**2** Unveiling the industry's most comprehensive custom ASIC offering

**3** The only complete data infrastructure product portfolio in the industry

**4** Delivering advanced technology and IP at the leading edge

**5** Global teams delivering products first time right with flexible business models



Q&A



Essential technology, done right™